

HSF RoHS 非正式图纸，仅供参考

REV	ECN NO	DESCRIPTION	DATE	NAME
A	—	NEW	09/02-'22	Steven

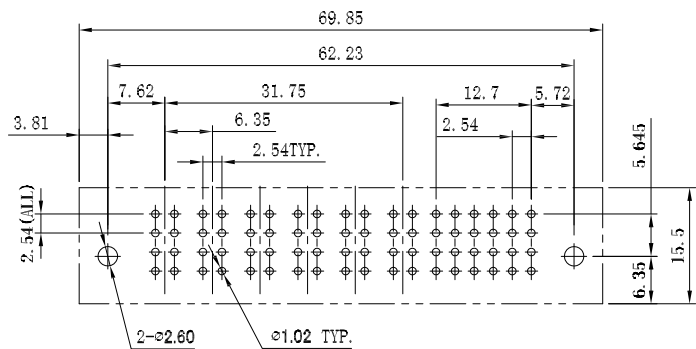
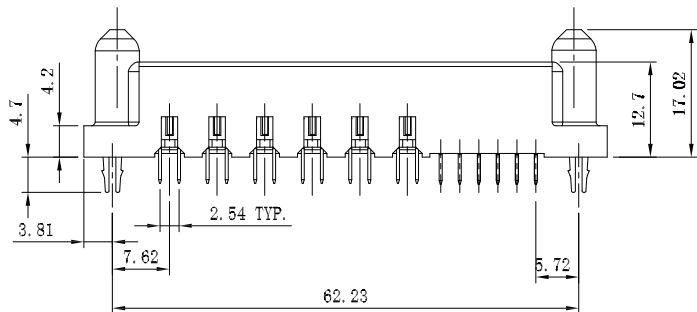
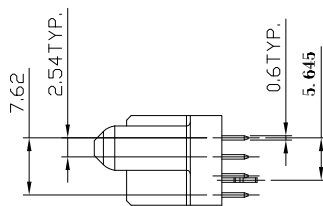
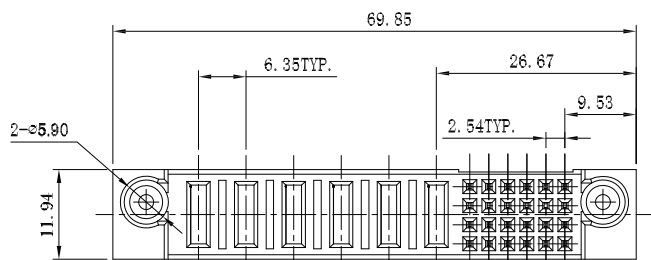
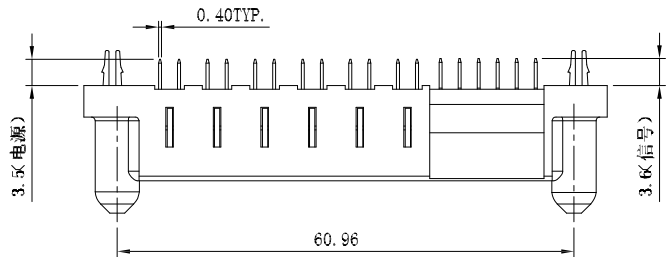

推荐PCB开孔尺寸(公差±0.05)

注:

1. 材质:

- A. 端子: 高性能铜合金
- B. 胶壳: 耐高温热塑性塑料. UL94V-0, 黑色.

2. 电镀:

- A. 电源端子: 镀金在接触区域, 镀雾锡在焊锡区域, 整个端子镍底;
- B. 信号端子: 镀金在接触区域, 镀雾锡在焊锡区域, 整个端子镍底;
- C. 固定脚: 镀雾锡在镍底上;

3. 电性能要求:

额定电压: 电源端子250 Vac; 信号端子50 Vac;
 额定电流: 电源端子40 A MAX, 信号端子2.5 A MAX;
 耐电压: 2500 VAC 电源端子 1 分钟无击穿, 1000 VAC 信号端子 1 分钟无击穿,
 绝缘电阻: 2000 MEG OHM MIN 电源端子; 2000 MEG OHM MIN 信号端子;
 接触电阻: 电源端子 ≤ 2 mΩ; 信号端子 ≤ 20 mΩ;
 工作温度: -40° TO +125° C

4. 机械性能要求:

插拔寿命: 250 次;

5. 包装方式: 吸塑盒包装;

6. 产品符合最新ROHS标准

Ordering Information

LBT X XX X XXXX

Code	PIN Number	Packing	Serial No
M: MALE	1~99	A: 袋装	0001~9999
F: FEMALE	(单排的PIN数)	B: 管装	
(不适用时用0表示)		C: 盘装	
		D: 卷装	
		E: 袋加盒	
		F: 其它	

LDCONN 东莞连大精密制品有限公司 DongGuan LianDa Precision Products Co., LTD

STANDARD TOLERANCE (EXCEPT SPECIFIED)	
LINER	ANGLES
.0 ±0.30	0.° ±3°
.00 ±0.20	.0° ±2°
.000 ±0.10	.00° ±1°

TITLE	BTB-M 电源连接器 24S+06p (直式插座)	DRAWN BY	Steven	09/02-'22
PART NO.	LBTF24C0001	CHECKED BY		
DRAWING NO.		APPROVED BY		
SCALE	1:1	UNIT	mm	PAGE 1/1
				SIZE A4

HSF RoHS 非正式图纸，仅供参考

REV	ECN NO	DESCRIPTION	DATE	NAME
A	—	NEW	09/02-'22	Steven

注:

1. 材质:

A. 端子: 铜合金

B. 胶壳: 耐高温热塑性塑料. UL94V-0, 黑色.

2. 电镀:

A: 电源端子: 接触区域镀金, 镀雾锡在焊锡区域, 整个端子镍底;

B: 信号端子: 接触区域镀金, 镀雾锡在焊锡区域, 整个端子镍底;

3. 电性能要求:

操作电压: 电源端子250 Vac; 信号端子50 Vac;

操作电流: 电源端子40A; 信号端子2.5A;

耐电压: 2500V DC电源端子1分钟无击穿, 1000V DC信号端子1分钟无击穿;

绝缘电阻: 2000 MEG OHM MIN电源端子; 2000 MEG OHM MIN信号端子;

接触电阻: 电源端子 $\leq 2 \text{ m}\Omega$; 信号端子 $\leq 20 \text{ m}\Omega$;

工作温度: -40°C TO $+125^\circ\text{C}$

4. 机械性能要求:

插拔寿命: 250 次;

5. 包装方式: 防静电吸塑盒包装;

6. 产品符合最新RoHS标准;

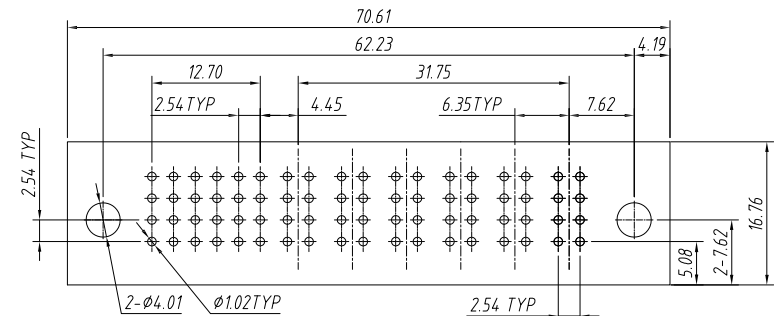
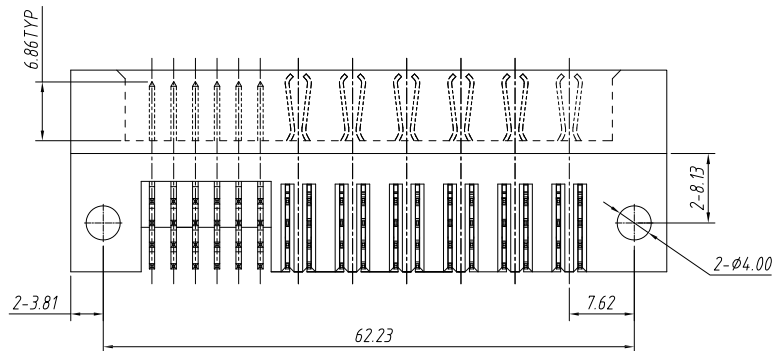
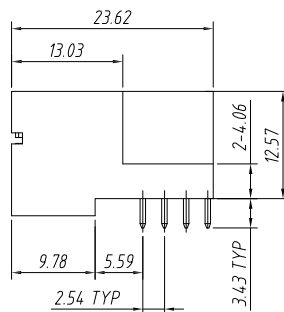
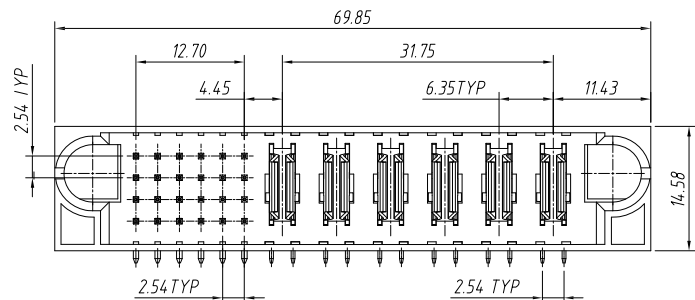
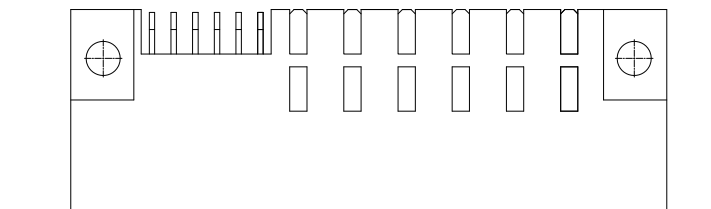

推荐PCB开孔尺寸(±0.05)

Ordering Information

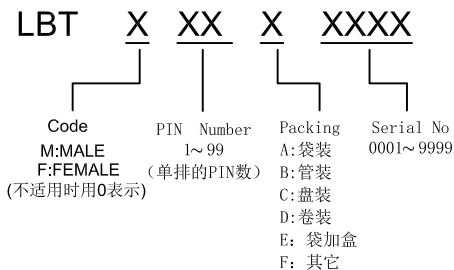

LDCONN 东莞连大精密制品有限公司
連大 DongGuan LianDa Precision Products Co., LTD

STANDARD TOLERANCE (EXCEPT SPECIFIED)	
LINER	ANGLES
.0 ±0.30	0.° ±3°
.00 ±0.20	.0° ±2°
.000 ±0.10	.00° ±1°

TITLE	BTB-M 电源连接器 24S+06p (直式插头)	DRAWN BY	Steven	09/02-'22
PART NO.	LBTM24C0001	CHECKED BY		
DRAWING NO.		APPROVED BY		
SCALE	1:1	UNIT	mm	PAGE 1/1
				SIZE A4